

ITEM	QTY.	DESCRIPTION	PART NUMBER					BP	BN	BV	FB	PR	RN	RB	DP	PA
			1 inch	2 inch	3 inch	4 inch	6 inch									
1	1	Washer	4543		4491			X	X	X	X	X	X	X		
2	1	Thread Seal	4542		4488			X	X	X	X	X	X	X		
3	1	O-Ring			155			X	X	X	X	X	X	X		
4	6	Filter Screen			619			X	X	X	X	X	X	X		
5	1	Pilot Plug	3017		112			X	X	X	X	X	X	X	X	
6	1	Gasket Pilot Seat	3018		118			X	X	X	X	X	X	X	X	
7	1	Pilot Seat	3016		113			X	X	X	X	X	X	X	X	
8	1	Diaphragm Stabilizing	3014		110			X	X	X	X	X	X	X	X	
9	1	Pilot Seat	3015		565			X	X	X	X	X	X	X	X	
10	1	Spacer Ring	-----		7437			X	X	X	X	X	X	X	X	
11	1	Diaphragm	3011P		5259P			X	X		X	X	X	X	X	
12	1	Spring Helical Conical	3008		108			X		X	X	X		X	X	
	1	Spring	3008		585				X				X			
13	1	Diaphragm Stabilizing	3014		6520									X		
14	1	Gasket Bonnet	4554		276									X		
15	1	Spring Booster (Ductile only)	-----		566					X						
16	1	Diaphragm (Ductile only)	3011P		688					X						
17	1	Diaphragm	127	1706	1640	2015	2140	X	X	X	X	X	X	X	X	
18	1	Gasket Body	195	196	197	198	199	X	X	X	X	X	X	X	X	
19	2	Back Up	148T	149T	150T	151T	152T	X	X		X	X	X	X	X	
20	1	O-Ring	153	154	155	156	157	X	X		X	X	X	X	X	
21	1	Seat	163	164	165	166	167	X	X	X	X	X	X	X	X	
		Full Port														
22	1	Gasket Removable Seat	-----	276	277	196	279	X	X	X	X	X	X	X	X	
																Reduced Port
23	1	Nut	172	173	906		175	X	X	X	X	X	X	X	X	
					Full Port											
24	1	O-Ring	4552	5225	5226	5227	4086	X	X	X	X	X	X	X	X	
																Reduced Port
25	1	Spacer	-----	4557DS6	4561DS6	4566DS6	4571DS6	X	X	X	X	X	X	X	X	
26	1	Channel Seal	4551C	4557C	4561C	4566C	4571C	X	X	X	X	X	X	X	X	
27	1	Retainer	4632A	4557ES6	4561ES6	4566ES6	4571E26	X	X	X	X	X	X	X	X	

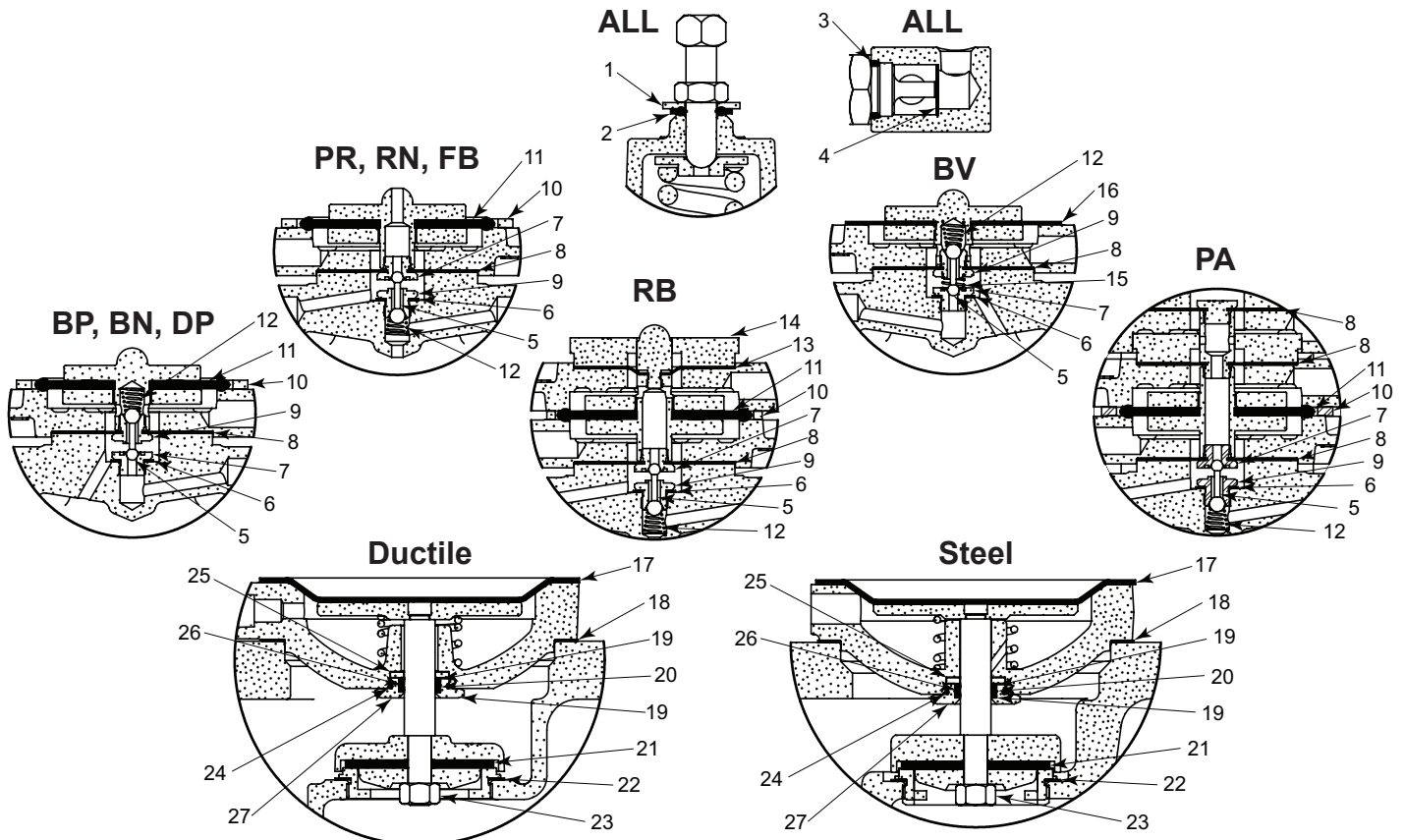

All Pictures shown are for illustration purpose only. Actual product may vary due to product enhancement.

For additional information & documentation visit www.kimray.com

PRESSURE REGULATORS

REPAIR KIT 1 INCH NON LUBE VALVES

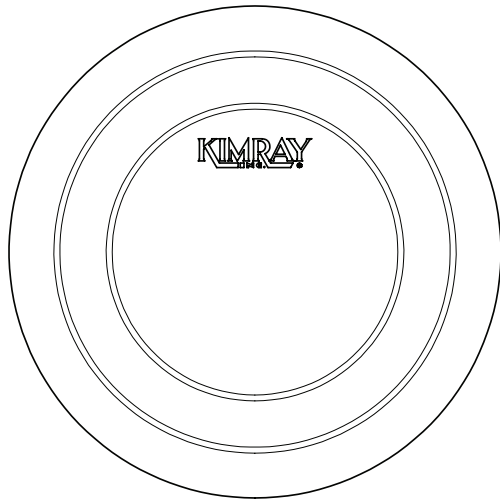

127

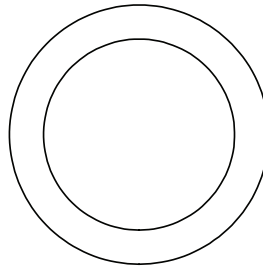

4554



163

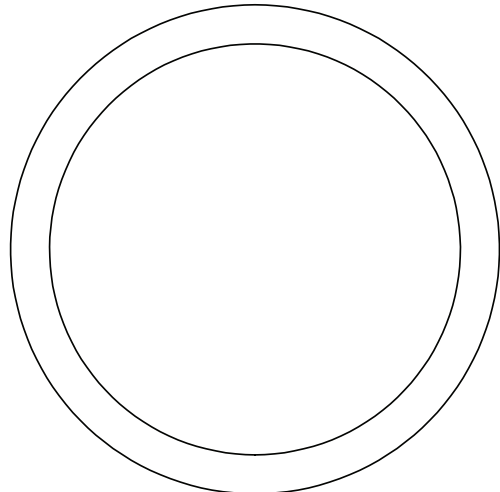

195

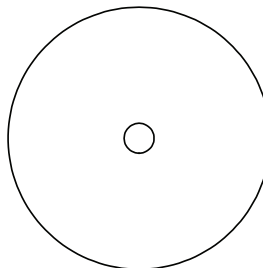

3014

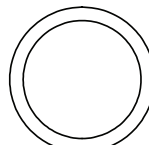

4552



4551C

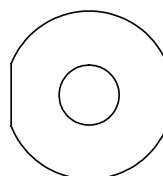

4632A



153



148T



3018



3015



3016



3017



3008

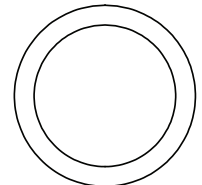

155

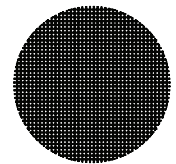

619

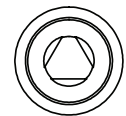

4542

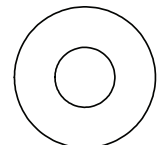

4543

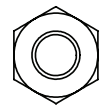

172

All Pictures shown are for illustration purpose only. Actual product may vary due to product enhancement.