

ITEM	QTY.	DESCRIPTION	2 INCH		3 INCH		4 INCH
			NEW STYLE	OLD STYLE	NEW STYLE	OLD STYLE	ALL STYLES
1	4	Snap Ring	941		975		
2	2	O-Ring	2131	----	5226	----	----
	2	Gasket	----	364	----	365	366
3	1	Packing	7662		355		356
4	1	Bushing	7660	----	7592	----	----
	1	Packing Ring	----	351	----	352	353
5	1	O-Ring	154	----	491	----	----
	1	Thrust Washer	----	360	----	361	362
6	1	O-Ring	265		154		
7	2	O-Ring	774		329		1872
8	1	O-Ring	329		330		331
9	1	Gasket	276		277		309
10	1	Seat	7498		7499		165
11	1	Gasket (used with Seat Disc)	7575		7576		----
12	1	Lock Nut	173		906		
13	2	Back Up	1685		1870		1871
14	1	O-Ring	808		802		2083

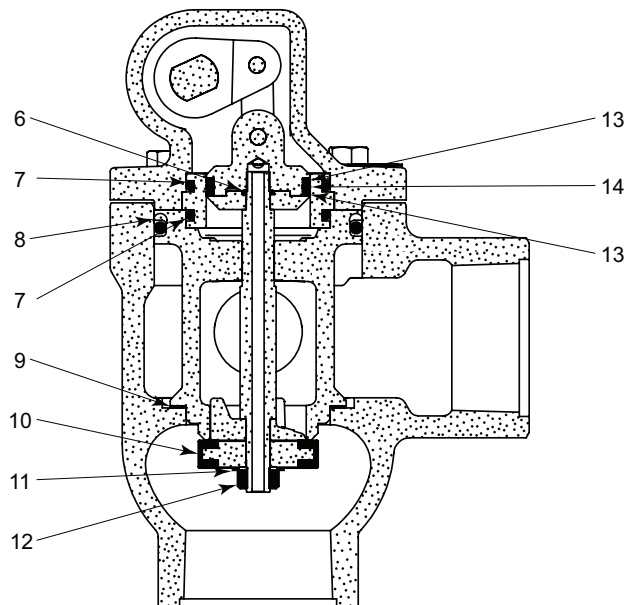
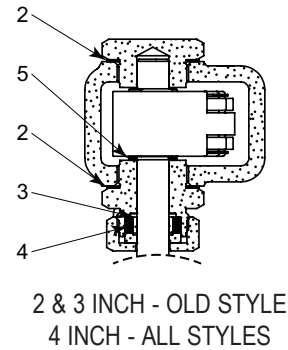
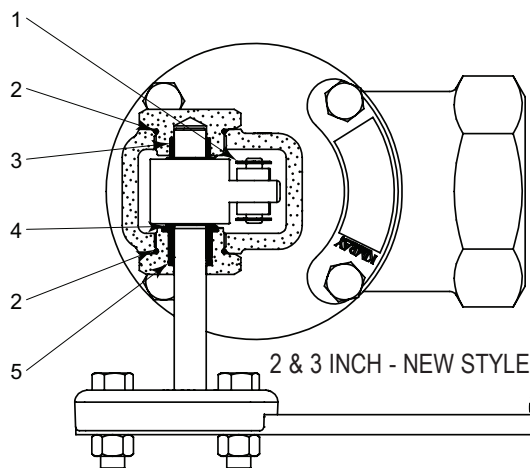

All Pictures shown are for illustration purpose only. Actual product may vary due to product enhancement.

For additional information & documentation visit www.kimray.com

LIQUID DUMP VALVES LEVER OPERATED



REPAIR KIT
2 INCH PISTON BALANCED

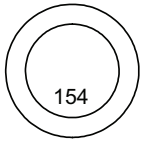

154

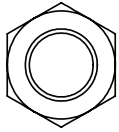

173



265

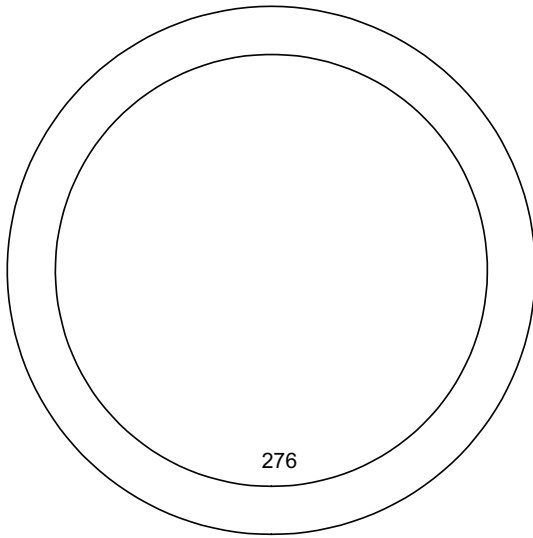

276

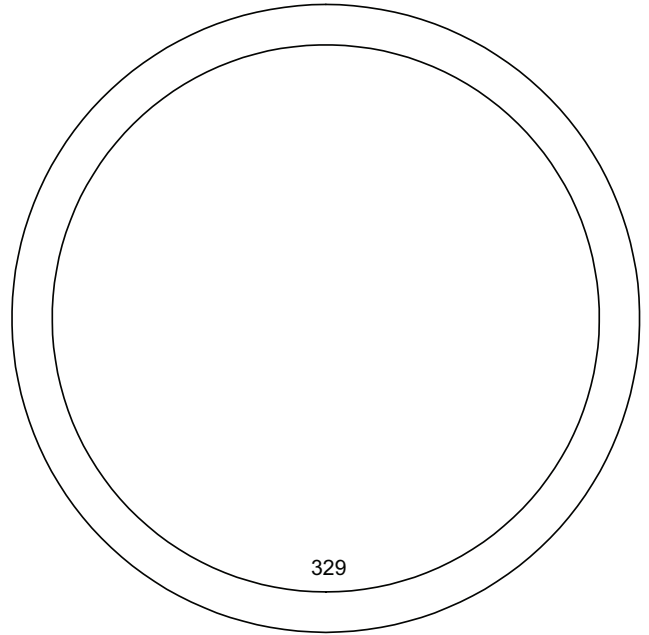

329

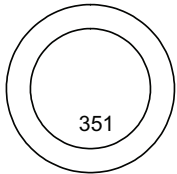

351

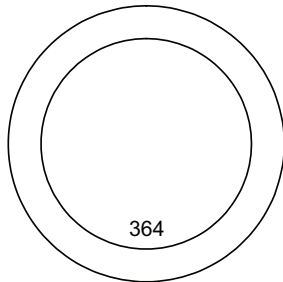

364

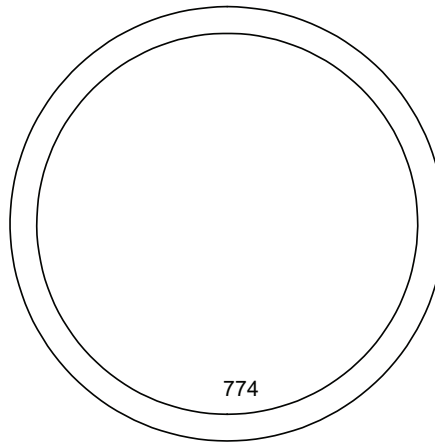

774

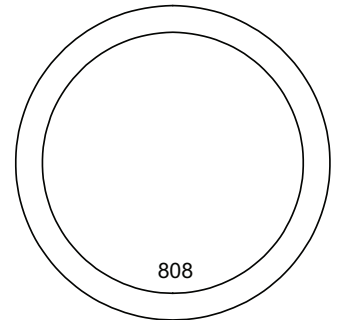

808

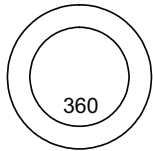

360



941

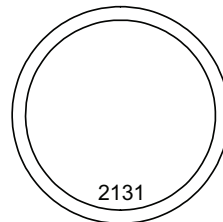

2131

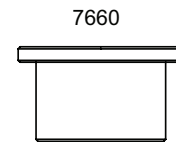

7660

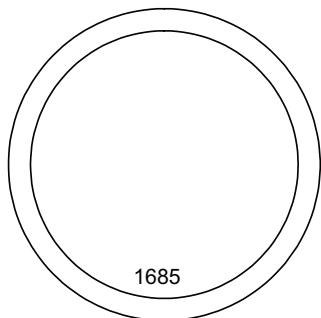

1685

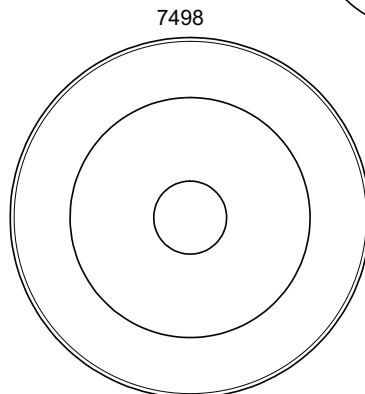

7498

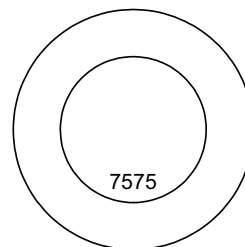

7575



7662

All Pictures shown are for illustration purpose only. Actual product may vary due to product enhancement.