

ITEM	QTY.	DESCRIPTION	2 INCH		3 INCH	
			CURRENT STYLE	OLD STYLE	CURRENT STYLE	OLD STYLE
1	1	Packing	7662		355	
2	2	Gasket	----	364	----	365
	2	O-Ring	2131		5226	
3	4	Snap Ring	941		975	
4	1	Bushing	7660		7592	
	(Qty)	Packing Ring	----	351	----	352
5	1	O-Ring	154		491	
	1	Thrust Washer	----	360	----	361
6	1	Gasket	5199		5223	
7	1	O-Ring	329		330	
8	2	Back Up	Full Port	1458	772	
		Reduced	7558	----		
9	1	O-Ring	Full Port	774Q	329	
		Reduced	808	----		
10	1	Seat	Full Port	311	165	
		Reduced	7498	----		
11	1	Gasket	276		277	
12	1	Lock Nut	173		906	

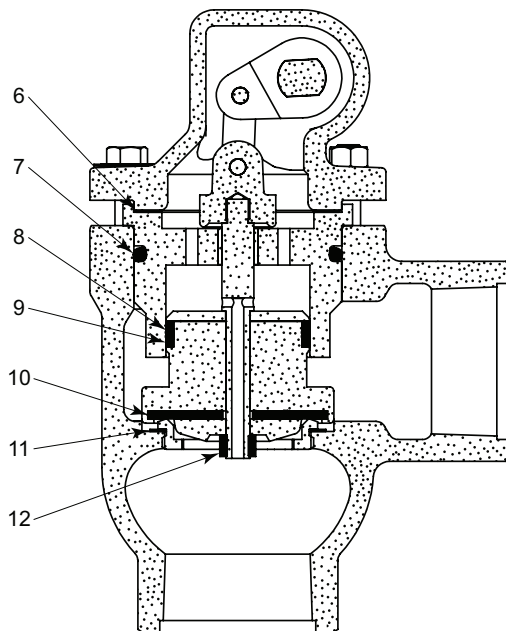
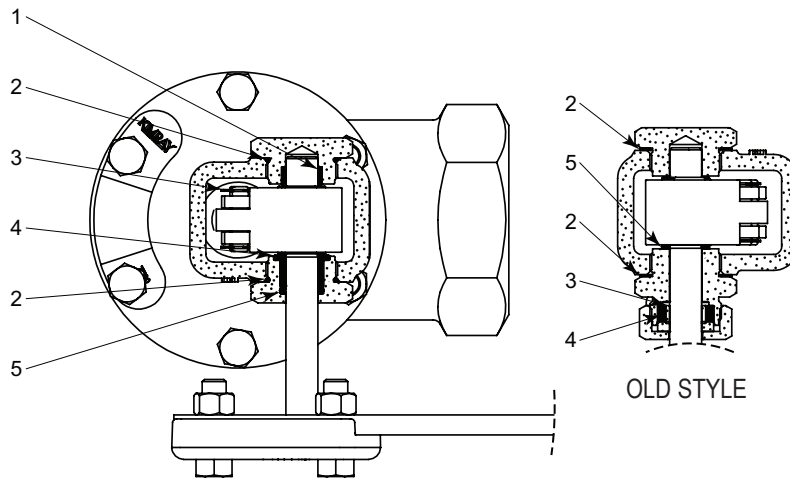

All Pictures shown are for illustration purpose only. Actual product may vary due to product enhancement.

For additional information & documentation visit www.kimray.com

LIQUID DUMP VALVES LEVER OPERATED



REPAIR KIT
3 INCH FULL PORT PISTON BALANCED THROTTLING

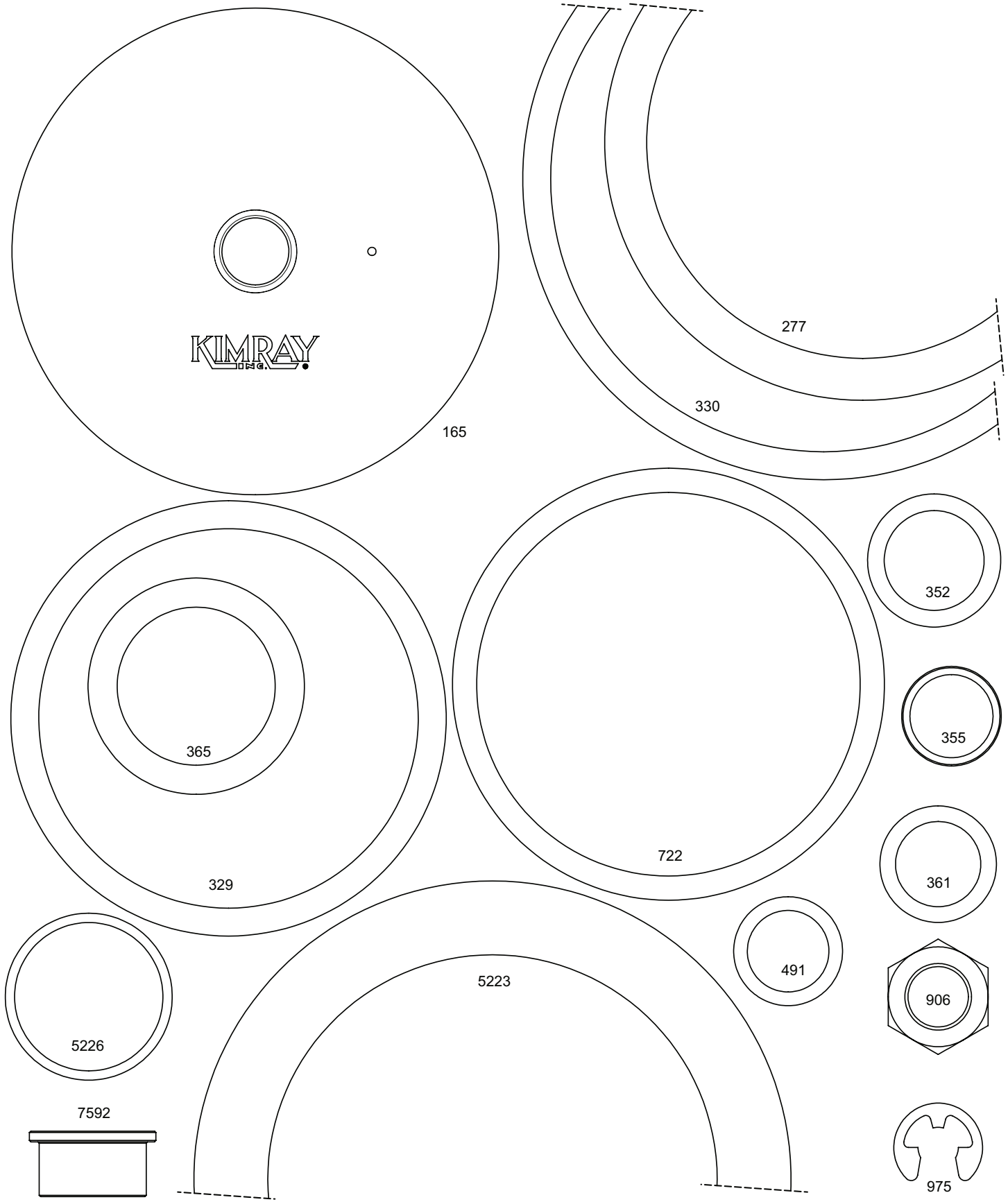

All Pictures shown are for illustration purpose only. Actual product may vary due to product enhancement.