

ITEM	QTY.	DESCRIPTION	2 INCH	3 INCH	4 INCH	6 INCH
1	4	Snap Ring	941		975	
2	2	Gasket		----	366	1789
	2	O-Ring	2131	5226		----
3	1	Packing	7662	355	356	1786
4	1	Bushing	7660	7592		----
	(Qty)	Packing Ring		----	353 x (1)	1787 x (2)
5	1	O-Ring	154	491		----
	1	Thrust Washer		----	362	1788
6	1	Diaphragm	335	336	4700	4315
7	1	O-Ring	329	330	331	2353
8	1	Gasket	276	277	309	2354
9	1	Seat	7498	7499	165	2356
10	1	Lock Nut	173		906	175

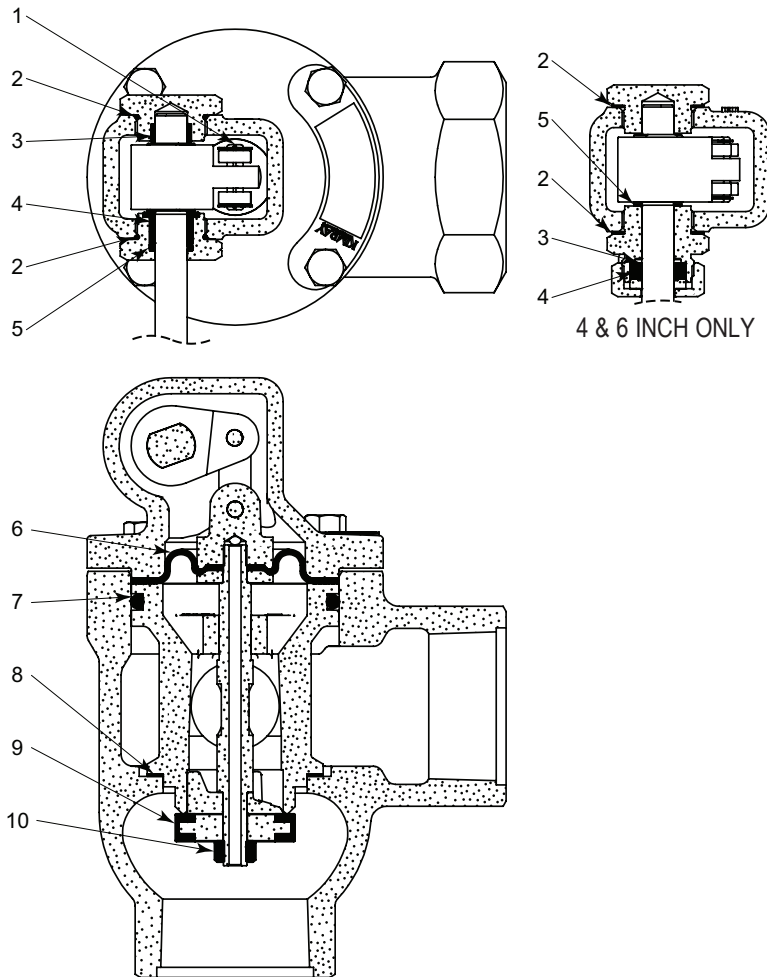

**LIQUID DUMP VALVES LEVER OPERATED**



REPAIR KIT  
4 INCH DIAPHRAGM BALANCED

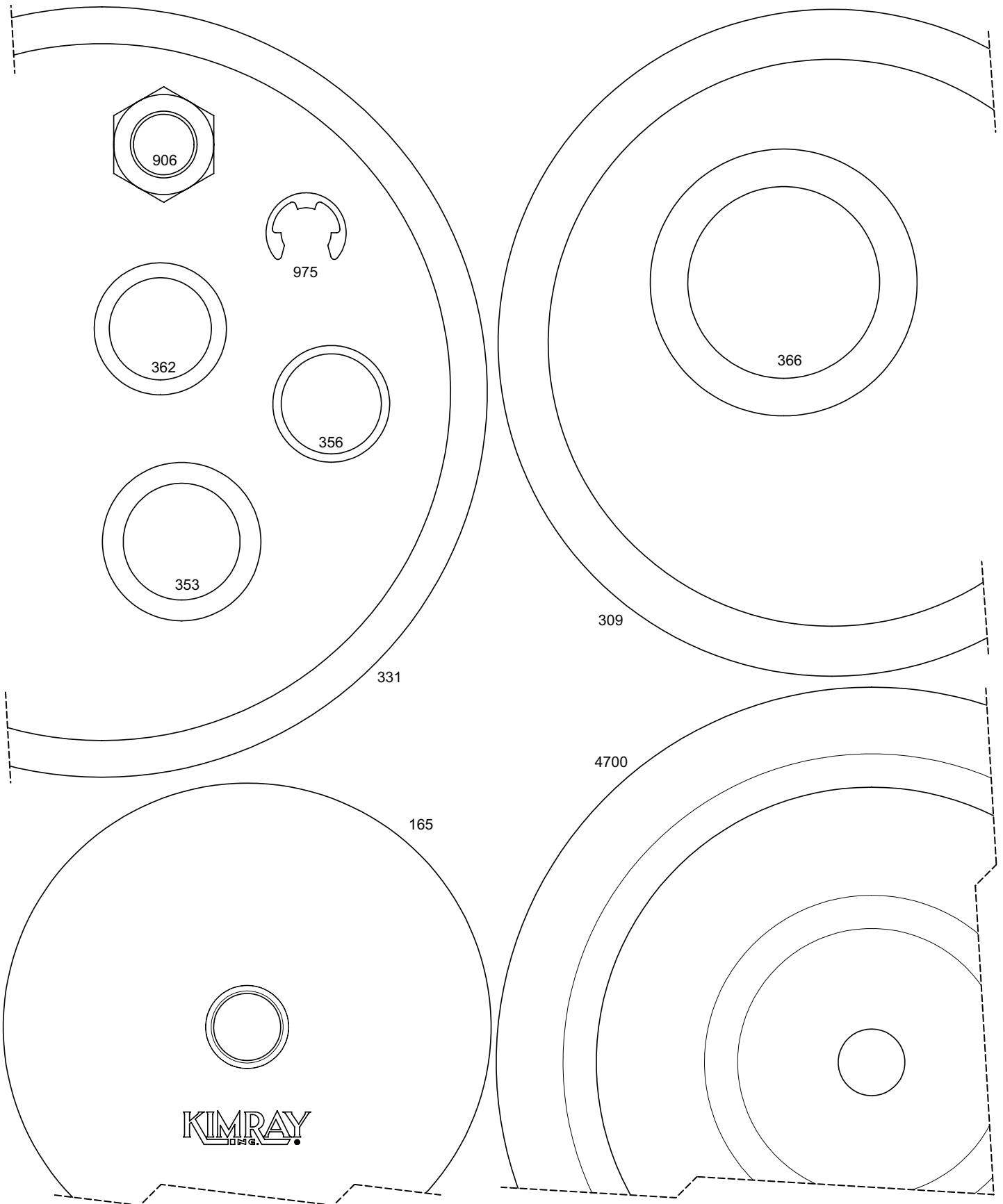

All Pictures shown are for illustration purpose only. Actual product may vary due to product enhancement.