

KIMRAY
INC.®

INSTALLATION
OPERATION &
MAINTENANCE
GUIDE



REPAIR TOOLS

HIGH PRESSURE CONTROL VALVES



STEM-GUIDED, NON-BALANCED

Valve Connection Size	Seat and Cage Removal Tool	Seat Removal Tool	Diaphragm Nut Wrench
1"	3032	615	476DNW
2"	3033	614	4356DNW

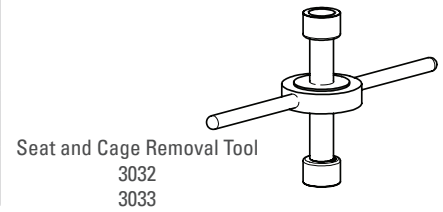

CAGE-GUIDED, BALANCED

Valve Connection Size	Seat Installation Tool	Upper Cage Puller	Diaphragm Nut Wrench
2"	6670	5296	4356DNW
3"	6826	5297	4965DNW
4"	5561	5298	4965DNW
6"	5561	6402	----
8"	5561	6651	----
10"	5561	6651	----

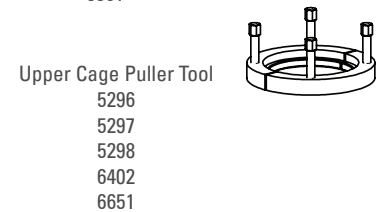
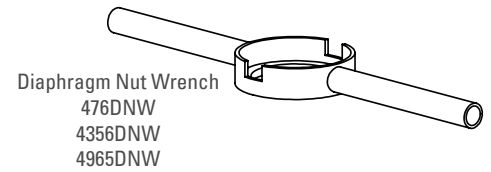

THREE-WAY VALVES



LOW PRESSURE NON-BALANCED

		1" Valve Connection	2" Valve Connection	3" Valve Connection
Diaphragm Balanced 3-way	Diaphragm Nut Removal Tool	N/A	1471SNW	N/A
	Spring Compression Tool	N/A	5534	N/A

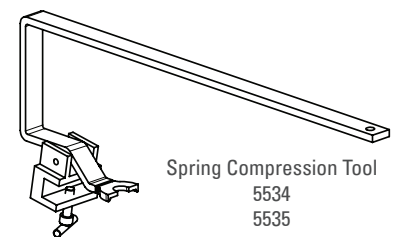

Piston Balanced 3-way	Diaphragm Nut Removal Tool	N/A	1471SNW	1859SNW
	Spring Compression Tool	N/A	5534	5535
	Upper Seat Wrench	N/A	2276SW	N/A



High Pressure 3-way	Lower Seat Wrench	2130SW	N/A	N/A
----------------------------	-------------------	--------	-----	-----

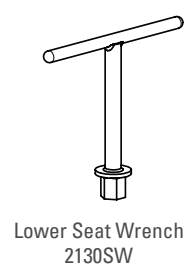
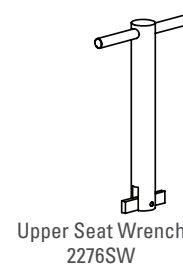

Splitter Valve	No Special Tools Needed			
-----------------------	-------------------------	--	--	--

LOW PRESSURE CONTROL VALVES



LOW PRESSURE, NON-BALANCED

		1/2" Trim	1" Trim
1" Valve Connection	Seat Removal Tool	1349SW	Not Needed
	Stem Guide	6431	1851

		1" Trim, Ductile Body	1" Trim, Steel Body	2" Trim
2" Valve Connection	Seat Removal Tool	706HTSW	4005SW	6945SW
	Stem Guide	1852		1852

		1-5/8" Trim, Ductile Body	1-5/8" Trim, Steel Body	3" Trim
3" Valve Connection	Seat Removal Tool	1219HTSW	1219SW	6946SW
	Stem Guide	1853		1853

		2" Trim, Ductile Body	2" Trim, Steel Body	4" Trim
4" Valve Connection	Seat Removal Tool	1220HTSW	1220SW	6947SW
	Stem Guide	1854		1854

		3" Trim, Ductile Body	3" Trim, Steel Body	6" Trim
6" Valve Connection	Seat Removal Tool	1221HTSW	1221SW	6948SW
	Stem Guide	1855		1855

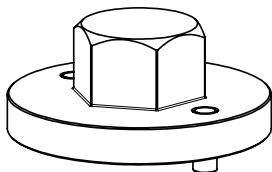

Seat Removal Tool
706HTSW
1219HTSW
1220HTSW
1221HTSW
1349SW

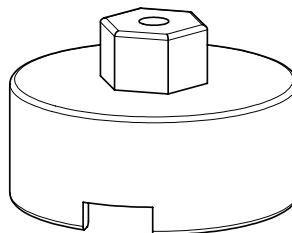

Seat Removal Tool
4005SW
1219SW
1220SW
1221SW

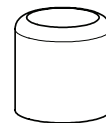

Stem Guide
1852
1853
1854
1855

LEVER OPERATED LIQUID DUMP VALVES



	Diaphragm Balanced	Piston Balanced	Piston Balanced Throttling
Valve Connection Size	No Special Tool Required	No Special Tool Required	Seat Removal Tool
2"	N/A	N/A	6945SW
2" with 1" Reduced Trim	N/A	N/A	7701SW for CXA5 6945SW for CAZ5
3"	N/A	N/A	6946SW
4"	N/A	N/A	
6"	N/A		

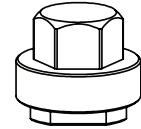

Seat Removal Tool 6945SW

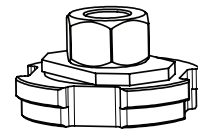

Seat Removal Tool 6946SW

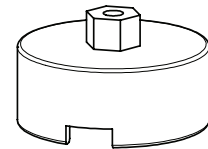

Seat Removal Tool 7701SW

WEIGHT OPERATED DUMP VALVES



	2" Valve Connection	3" Valve Connection	4" Valve Connection	6" Valve Connection
Seat Wrench	384SW	385SW	386SW	1771SW

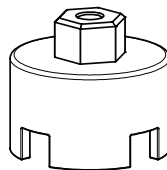

Seat Wrench
384SW
385SW
386SW

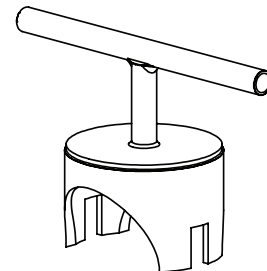

Seat Wrench
1771SW

PNEUMATICALLY OPERATED LIQUID DUMP VALVES



		2" Valve Connection	3" Valve Connection	4" Valve Connection	6" Valve Connection
Diaphragm Balanced	Diaphragm Nut Removal Tool	1471SNW	1472SNW	Not Needed	706HTSW
	Spring Compression Tool	5534	5535	5535	6447
	Stem Guide Wrench	2463SW	2464SW	2464SW	N/A
	Stem Guide (O-Ring Protector)	1852	1853	1854	1855

Piston Balanced	Piston Removal Tool	1471SNW	1859SNW	1859SNW	
	Spring Compression Tool	5534	5535	5535	
	Stem Guide Wrench	2463SW	2464SW	2464SW	
	Stem Guide (O-Ring Protector)	1852	1853	1854	

Piston Balanced Throttling	Seat Removal Tool	6945SW	6946SW	6947SW	
	Spring Compression Tool	5534	5535	5535	
	Stem Guide Wrench	N/A	N/A	N/A	
	Stem Guide (O-Ring Protector)	1852	1853	1854	

LPHV	Seat Removal Tool	7701SW	7699SW	7925SW	
-------------	-------------------	--------	--------	--------	--

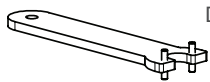

Diaphragm Removal Tool
1471SNW
1472SNW

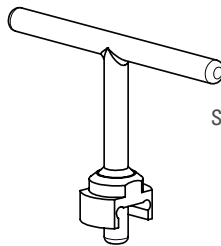

Stem Guide Wrench
2463SW
2464SW

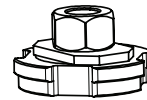

Seat Removal Tool
6945SW
6946SW
6947SW

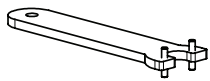

Piston Removal Tool
1471SNW
1859SNW

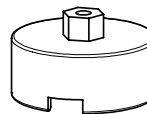

Seat Removal Tool
7701SW
7699SW
7925SW

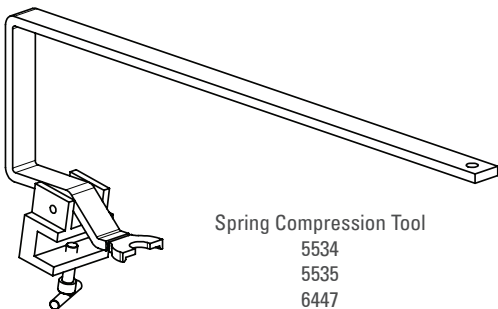

Spring Compression Tool
5534
5535
6447



Stem Guide
1852
1853
1854
1855

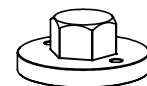

Diaphragm Nut Removal Tool
706HTSW

REGULATORS



PNEUMATIC

		1/2" Trim	1" Trim
1" Valve Connection	Seat Removal Tool	1349SW	
	Stem Guide	1851	

		1" Trim	2" Trim
2" Valve Connection	Seat Removal Tool	4934SW	6945SW or 272SW
	Stem Guide	1852	

		1-5/8" Trim	3" Trim
3" Valve Connection	Seat Removal Tool	Ductile - 1219SW Steel - 1219HTSW	6946SW or 273SW
	Stem Guide	1853	

		2" Trim	4" Trim
4" Valve Connection	Seat Removal Tool	Ductile - 1220SW Steel - 1220HTSW	6947SW or 274SW
	Stem Guide	1854	

		3" Trim	6" Trim
6" Valve Connection	Seat Removal Tool	Ductile - 1221SW Steel - 1221HTSW	6948SW or 275SW
	Stem Guide	1855	



Stem Guide
1851
1852
1853
1854
1855

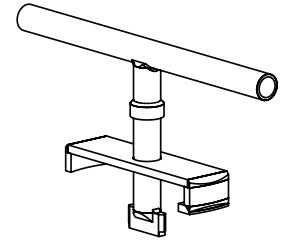

Handle Seat Removal Tool
272SW
273SW
274SW
275SW

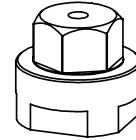

Seat Removal Tool
4934SW

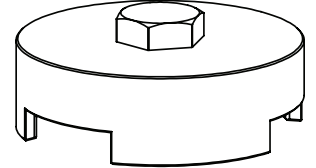

Seat Removal Tool
1219SW
1220SW
1221SW

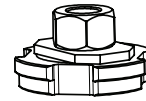

Seat Removal Tool
1349SW
6945SW
6946SW
6947SW
6948SW

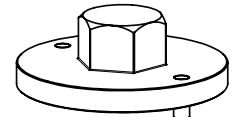

Seat Removal Tool
1219HTSW
1220HTSW
1221HTSW
1349SW

SPRING-LOADED BACK PRESSURE

		1" Trim, Ductile Body	1" Trim, Steel Body	2" Trim
2" Valve Connection	Seat Removal Tool	4005SW	4060SW	6945SW
	Stem Guide	1852		

		1-5/8" Trim, Ductile Body	1-5/8" Trim, Steel Body	3" Trim
3" Valve Connection	Seat Removal Tool	1219HTSW	N/A	6946SW
	Stem Guide	1853		

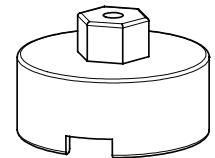

Seat Removal Tool
4005SW
4060SW
6945SW
6946SW



Stem Guide
1852
1853

GLYCOL PUMPS



ENERGY EXCHANGE

	Suction Seat Removal Tool	Seal Retainer Tool	Suction Seat Insertion Tool
1720 PV	615	4456	1542
2020 SC	615	4456	1542
4020 PV	615	4456	1542
5020 SC	614	4457	1543
9020 PV	614	4457	1543
10020 SC	614	4458	1544
21020 PV	614	4458	1544
20020 SC	614	4459	1545
45020 PV	614	4459	1545

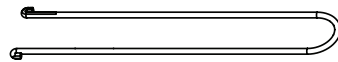

Suction Seat Removal Tool
615
614

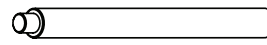

Seal Retainer Tool
4456
4457
4458
4459

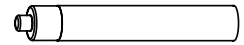

Suction Seat Insertion Tool
1542
1543
1544
1545

WHO WE ARE

Kimray is a manufacturer of oil and gas control equipment based in Oklahoma City, Oklahoma, USA.

Trusted for generations, Kimray has been creating simple, effective solutions for temperature, level, flow, and pressure control since 1948. Common applications include separation, heating, compression, dehydration, and artificial lift.

Buying from Kimray is about much more than the product. We are partners with hearts to serve. The relationships between our representatives and our customers extend from before the sale through the life of the product. Our focus is not on short-term profits but long-term growth for our customers.

Visit Kimray.com to learn more about our company and the products we create.



Kimray.com

